

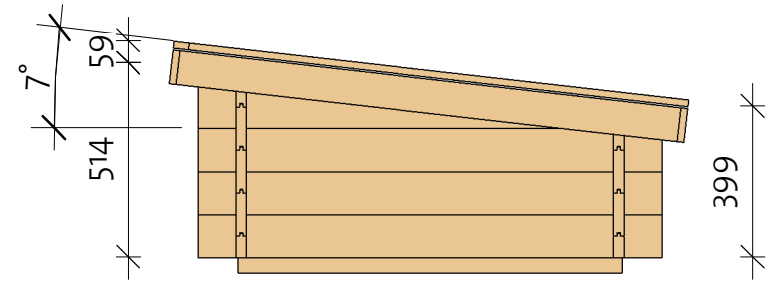

Robot Lawn Mower Garage I 28 (92x103)

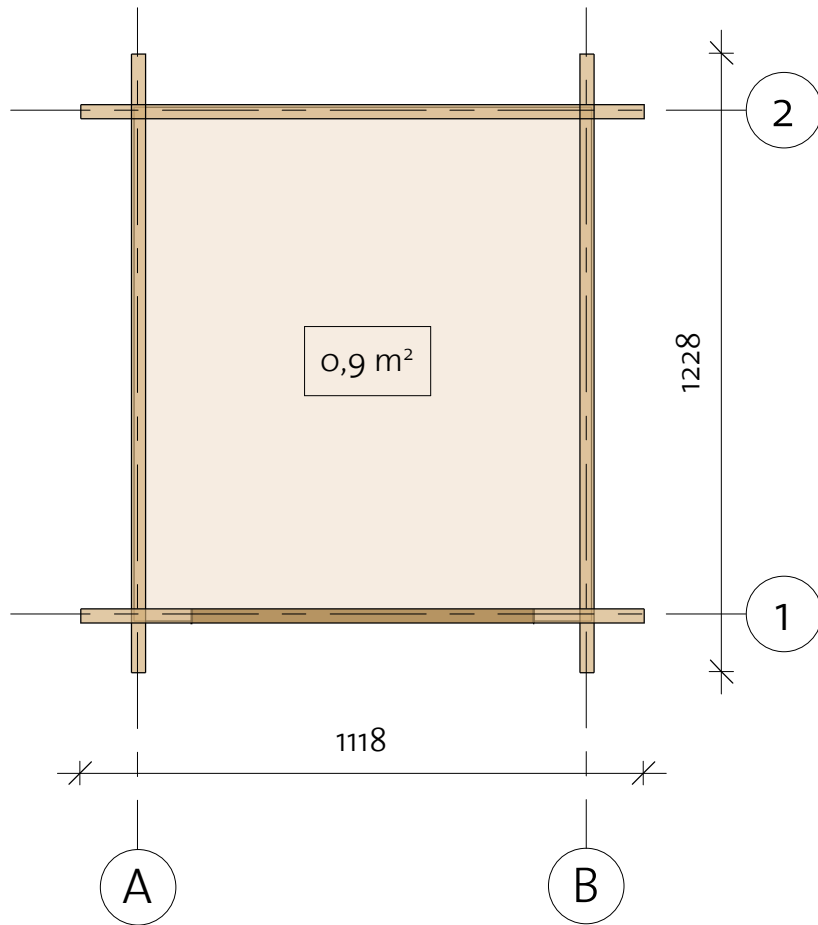
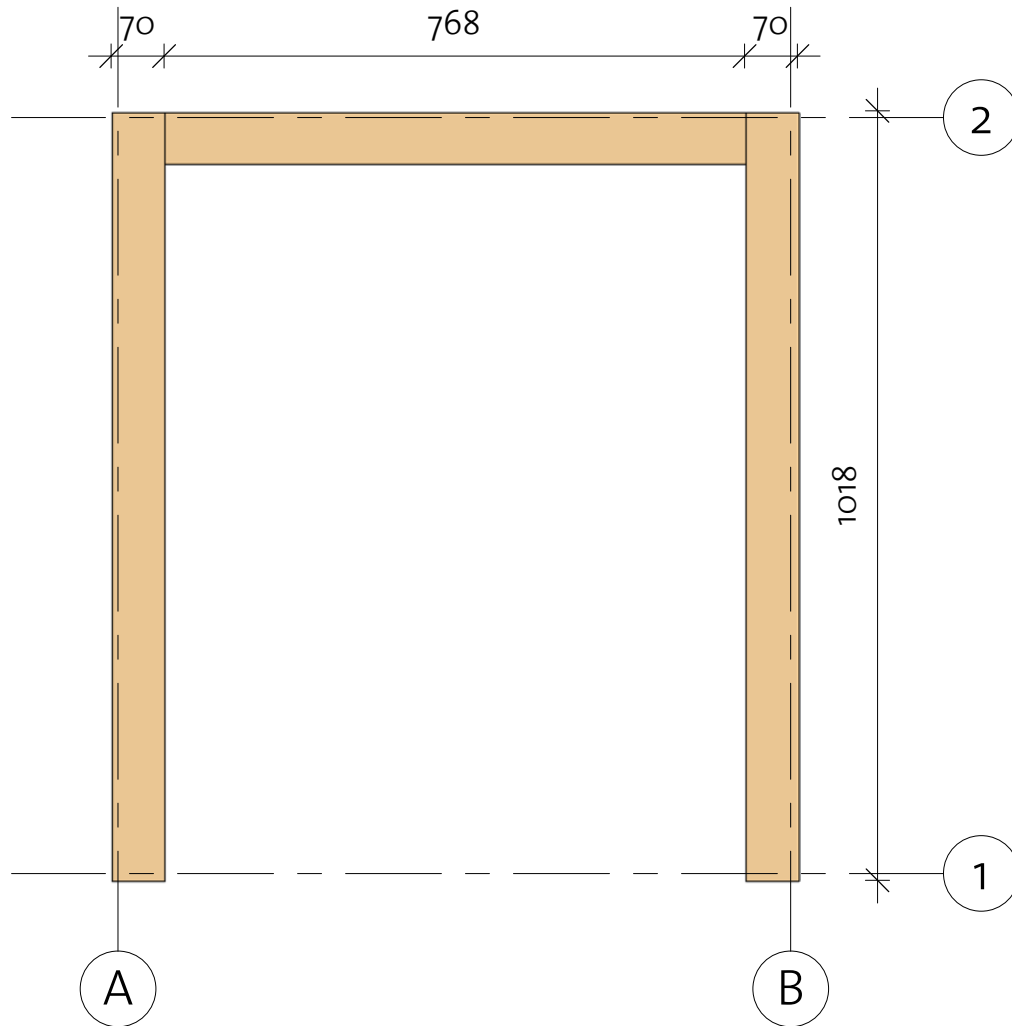

Robot Lawn Mower Garage I 28 (92x103)

Foundation



Impregnated foundation beams				
Mark	Type	Profile	Count	Length
IFB1	IFB 70x40		1	768
IFB2	IFB 70x40		2	1018

Robot Lawn Mower Garage I 28 (92x103)

Floor Plan

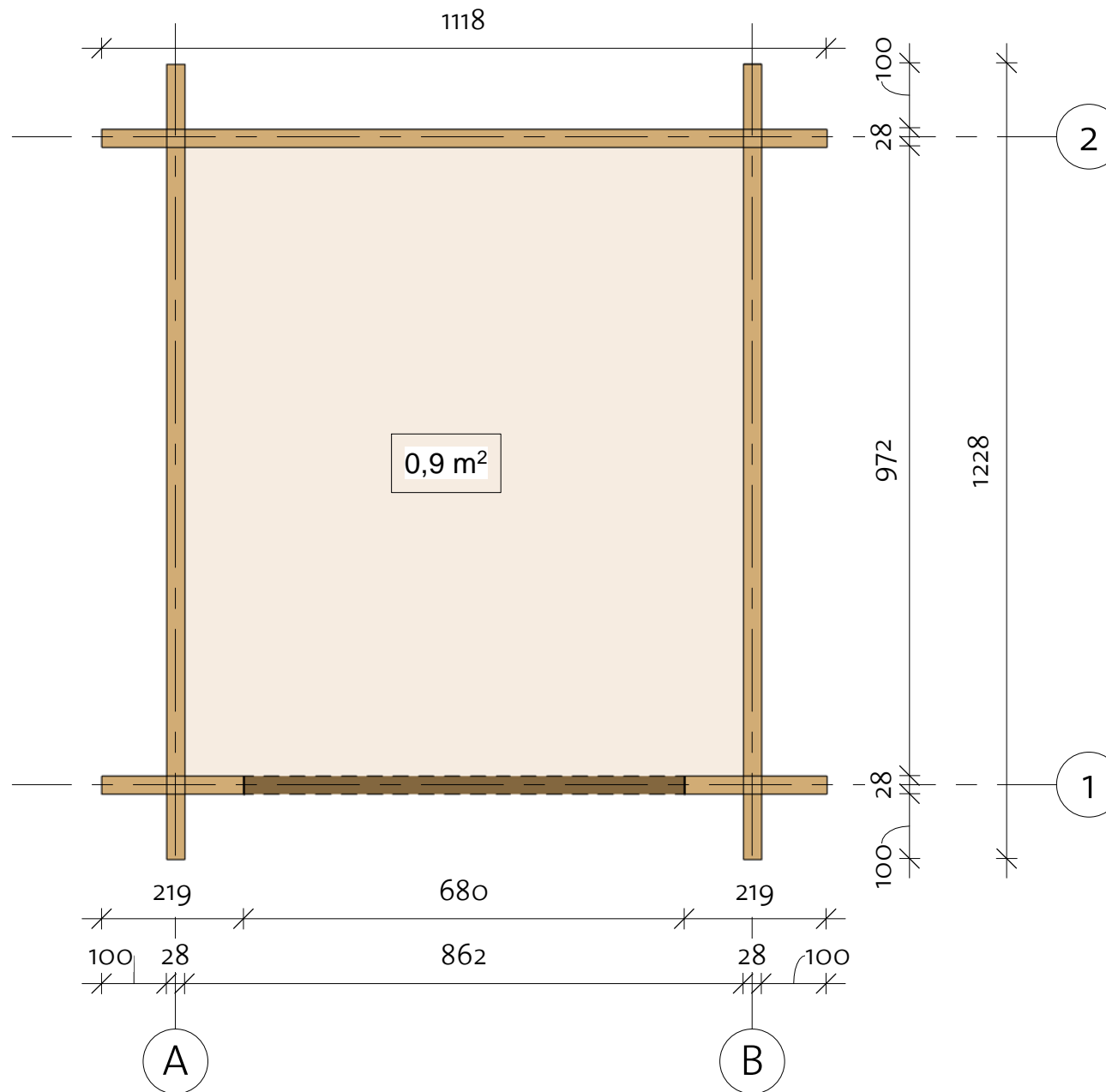

Robot Lawn Mower Garage I 28 (92x103)

Wall 1

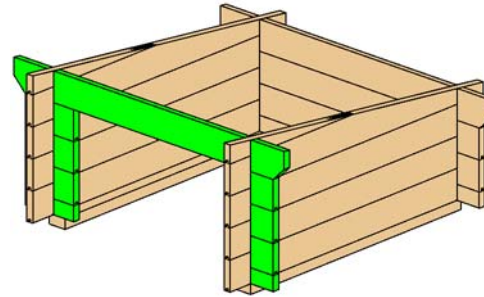

Wall 1			
Mark	Profile	Count	Cut Length
1BL-1	28x57	2	219
1LG-1	28x114	6	219
1TL-1	28x114	1	1218

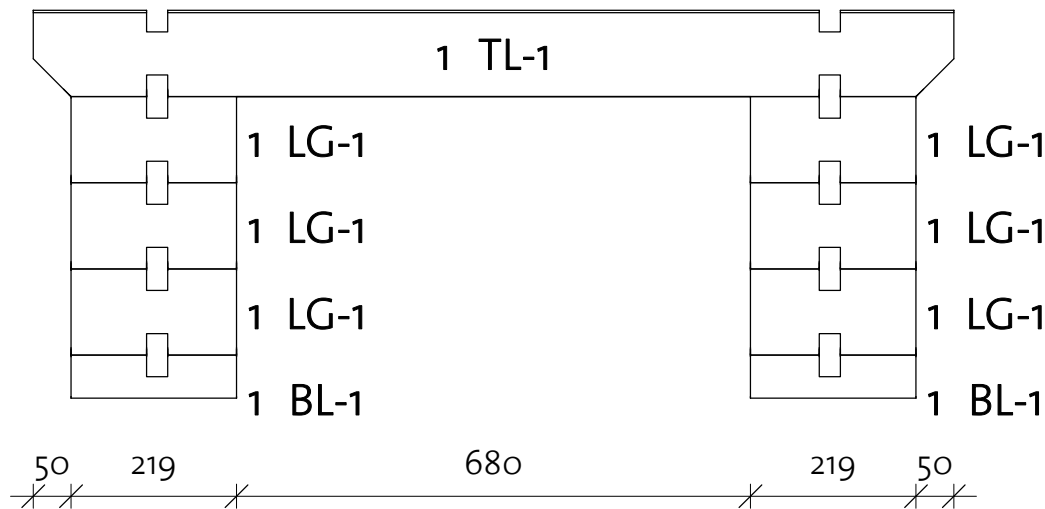

Log Profile Wall 1	
Profile	Profile
28x57	
28x114	
28x114	

Robot Lawn Mower Garage I 28 (92x103)

Wall 2

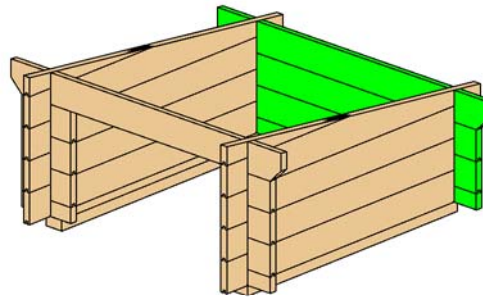

Wall 2			
Mark	Profile	Count	Cut Length
2BL-1	28x57	1	1118
2LG-1	28x114	2	1118
2TL-1	28x114	1	1218

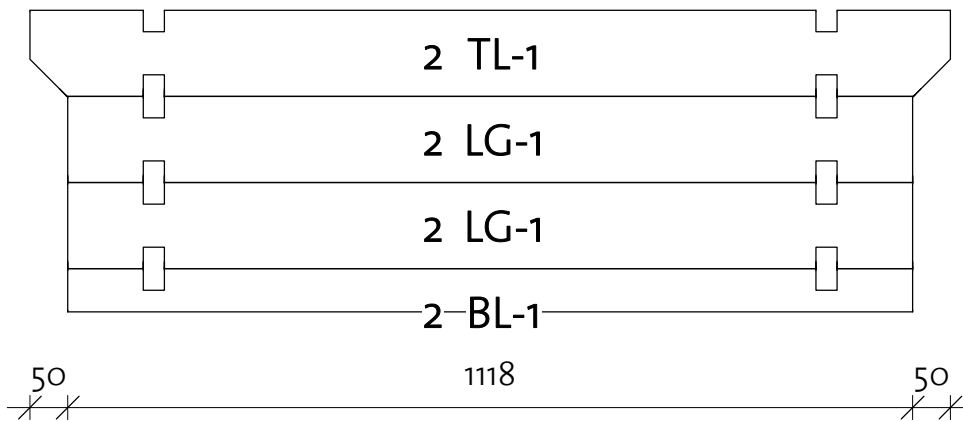

Log Profile Wall 2	
Profile	Profile

28x57	
28x114	
28x114	

Robot Lawn Mower Garage I 28 (92x103)

Wall A

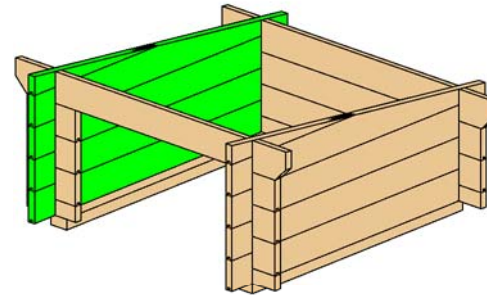

Wall A			
Mark	Profile	Count	Cut Length

ALG-1	28x114	1	601
ALG-2	28x114	1	1228
ALG-3	28x114	3	1228

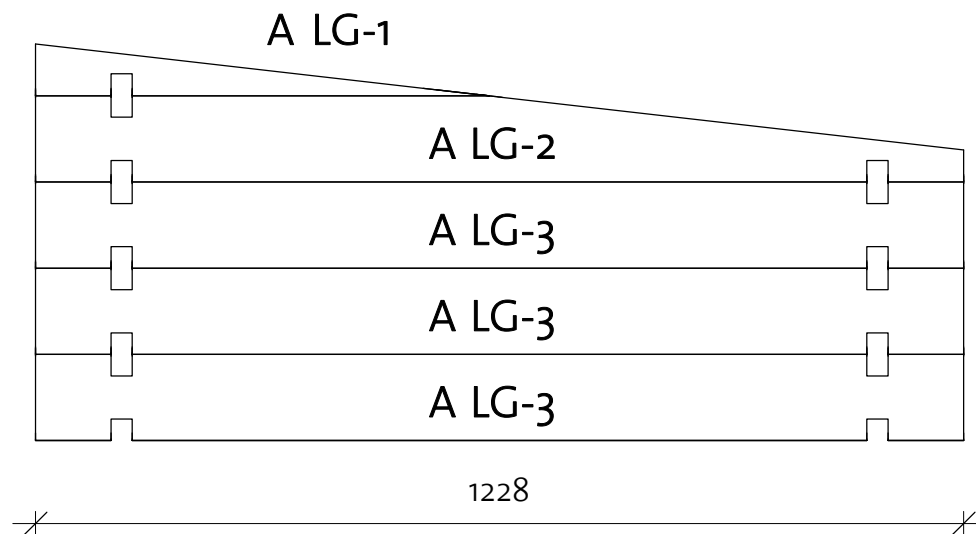

Log Profile Wall A	
Profile	Profile

28x114	
--------	--

Robot Lawn Mower Garage I 28 (92x103)

Wall B

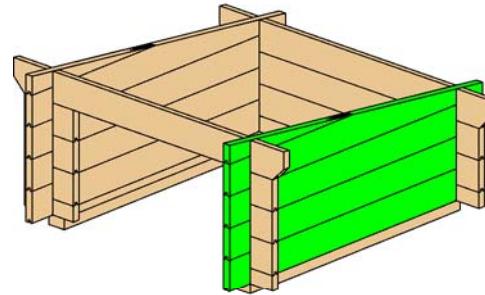

Wall B			
Mark	Profile	Count	Cut Length

BLG-1	28x114	1	601
BLG-2	28x114	1	1228
BLG-3	28x114	3	1228

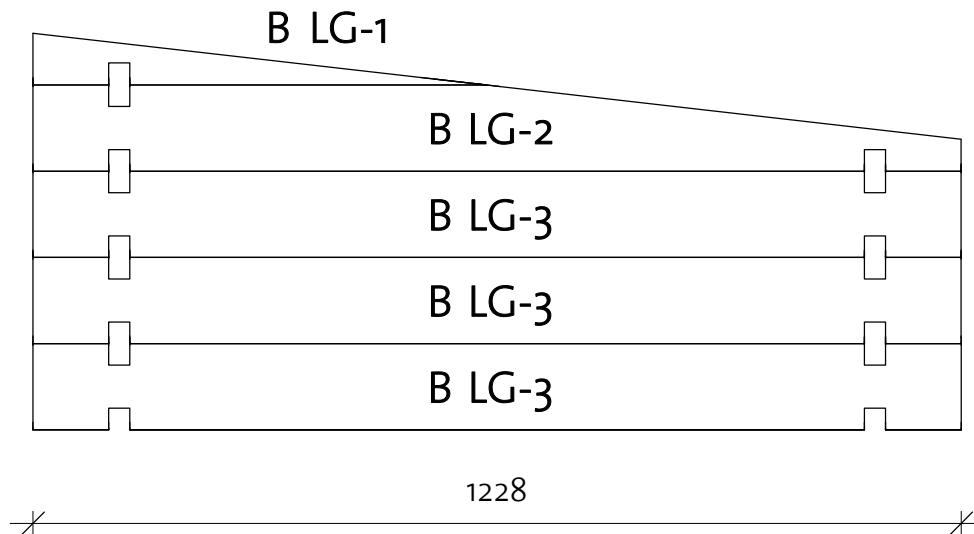

Log Profile Wall B	
Profile	Profile

28x114	
--------	--

Robot Lawn Mower Garage I 28 (92x103)

Roof 1

Roof				
Mark	Type	Profile	Count	Length
RB	17x114		11	1335

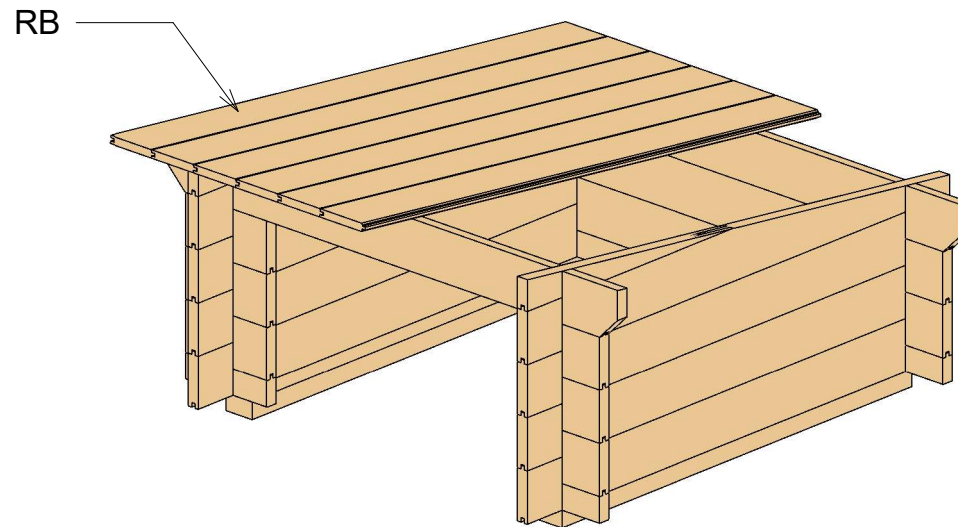

Robot Lawn Mower Garage I 28 (92x103)

Roof 2

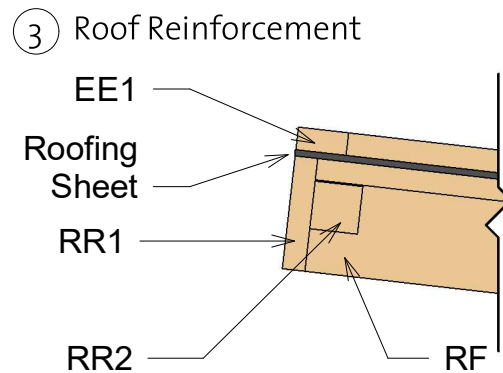
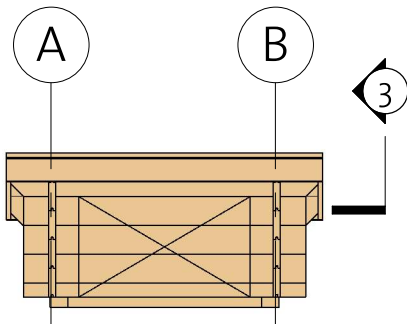
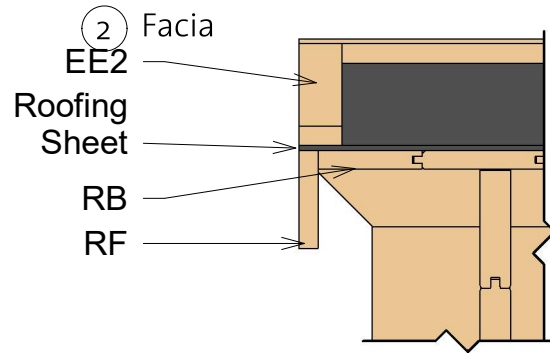
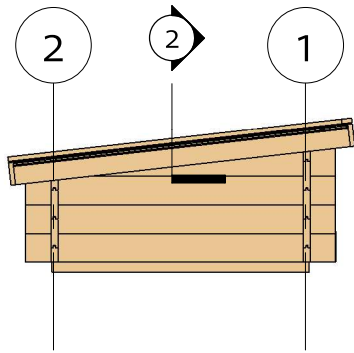

Fascia Schedule				
Mark	Type	Profile	Count	Length

EE1	Eave Edging 18x40		1	1254
EE2	Eave Edging 18x40		2	1331
RF	Roof Fascia 18x95		2	1335
RR1	Roof Fascia 18x95		2	1254
RR2	Roof reinforcement 38x38		2	1218



Type	Size	Count
------	------	-------

Sheet	1264x1381	1
-------	-----------	---





Robot Lawn Mower Garage I 28 (92x103)

List of all items 1

Impregnated foundation beams

Mark	Type	Profile	Count	Length
IFB1	IFB 70x40		1	768
IFB2	IFB 70x40		2	1018

Fascia Schedule

Mark	Type	Profile	Count	Length
EE1	Eave Edging 18x40		1	1254
EE2	Eave Edging 18x40		2	1331
RF	Roof Fascia 18x95		2	1335
RR1	Roof Fascia 18x95		2	1254
RR2	Roof reinforcement 38x38		2	1218

Roof

Mark	Type	Profile	Count	Length
RB	17x114		11	1335

Fasteners & Extras

Name	Type	Count
Hitblock	300-400 mm	
Screws	4,0 x 50	30
Screws	6,0 x 140	30
Screws	4,0 x 40	40

Type	Size	Count
------	------	-------

Sheet	1264x1381	1
-------	-----------	---

Robot Lawn Mower Garage I 28 (92x103)

List of all items 2

Wall 1			
Mark	Profile	Count	Cut Length

1BL-1	28x57	2	219
1LG-1	28x114	6	219
1TL-1	28x114	1	1218

Wall 2			
Mark	Profile	Count	Cut Length

2BL-1	28x57	1	1118
2LG-1	28x114	2	1118
2TL-1	28x114	1	1218



Wall A			
Mark	Profile	Count	Cut Length

ALG-1	28x114	1	601
ALG-2	28x114	1	1228
ALG-3	28x114	3	1228

Wall B			
Mark	Profile	Count	Cut Length

BLG-1	28x114	1	601
BLG-2	28x114	1	1228
BLG-3	28x114	3	1228

Log Profiles	
Profile	Profile

28x57	
28x114	

Log Profiles	
Profile	Profile

28x114	
--------	---